



043-055-1351

Made From Minimum 50% Recycled Content



SGBP 2017-814

P-Serie

Adjustable pedestals
for all types of
raised floors





P-Serie

Adjustable pedestals for all types of raised floors

Founded in 1987, Buzon Pedestal International (B.P.I. s.a) is the first European manufacturer of paving pedestals (screw jack) that can be adjusted by millimetre up to 600mm. Made of high quality polypropylene, they are able to bear loads of more than 1000 kg /pedestal. The P-Serie pedestals have been designed to support any kind of slab or tile, timber or composite wood decking on roofs, terraces, balconies, garden terraces, podiums and around swimming pools. They are also used for temporary floors like exhibition stands and very often for industrial floors in the chemical, mechanical or metallurgy industries and many other applications.

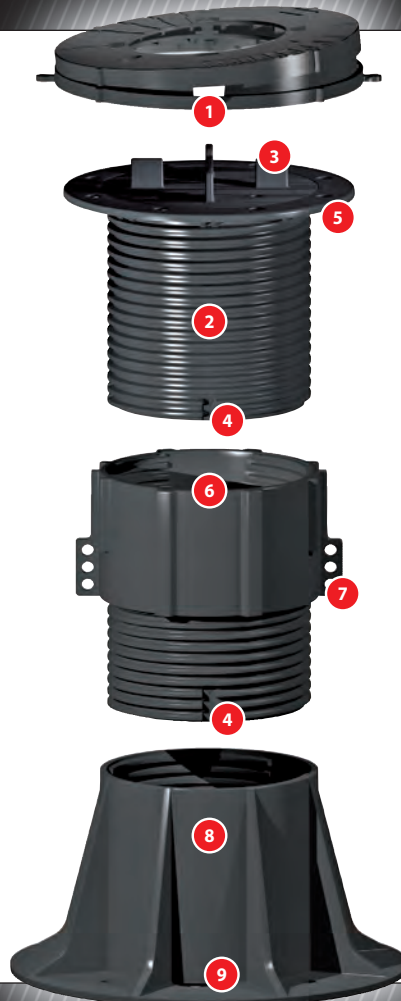

Basic components :

- Slope Corrector (0 to 5%)
- Top of fZWpedestal (surface = 175 cm²).
- Coupler
- Base of fZWpedestal (surface = 320 cm²).

The slope corrector PH5 (1) US compensate any slope up to 5% (slope from 0 to 5 cm per linear meter). It is clip fitted onto the top of the pedestal.

The top of pedestal (2) is screwed directly into the base of fZW pedestal (8) or into the coupler (6) if a height of 200mm is required. The head, with a diameter of 150 mm, is equipped with 4 tabs (3) 4,5mm thick that create an open joint between the tiles. The top of fZWpedestal is also available without these tabs to fix a joist in a timber decking system.

On the top of the pedestal and of the coupler, a safety notch at the bottom of the threaded part gives the adjustment limit in height (4).

On the head, 8 holes (5) of 8mm in diameter allow the use of nuts and of bolts for connections.

The coupler (6) is used when a height of the pedestals exceeding 200mm is required. Two guide wire hooks on the side (7) allow the pedestals to be braced giving better stability when the height exceeds 600mm.

The bottom of the base (8) is made of polypropylene with a thickness of 5mm and a 205mm diameter. It can be simply laid or fixed to structural ground.

The base is also provided with holes (9) for an easier water drainage.

PH5

Slope corrector

Made of polypropylene, the PH5 slope corrector, can compensate any slope up to 5% (slope from 0 to 5 cm per meter). For a good run-off of rain water, the minimum slope should be 2%.

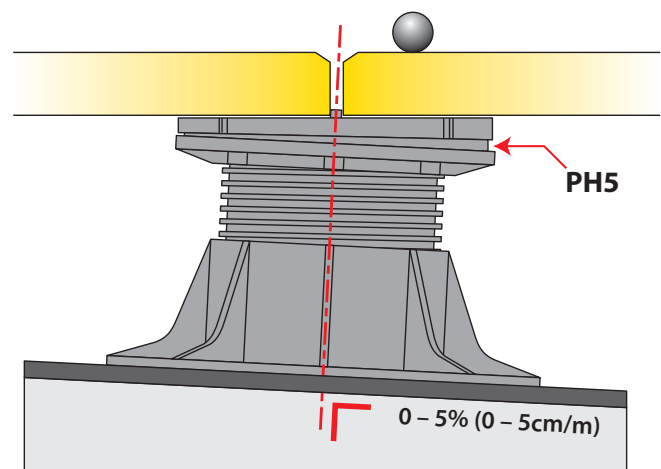

Applications

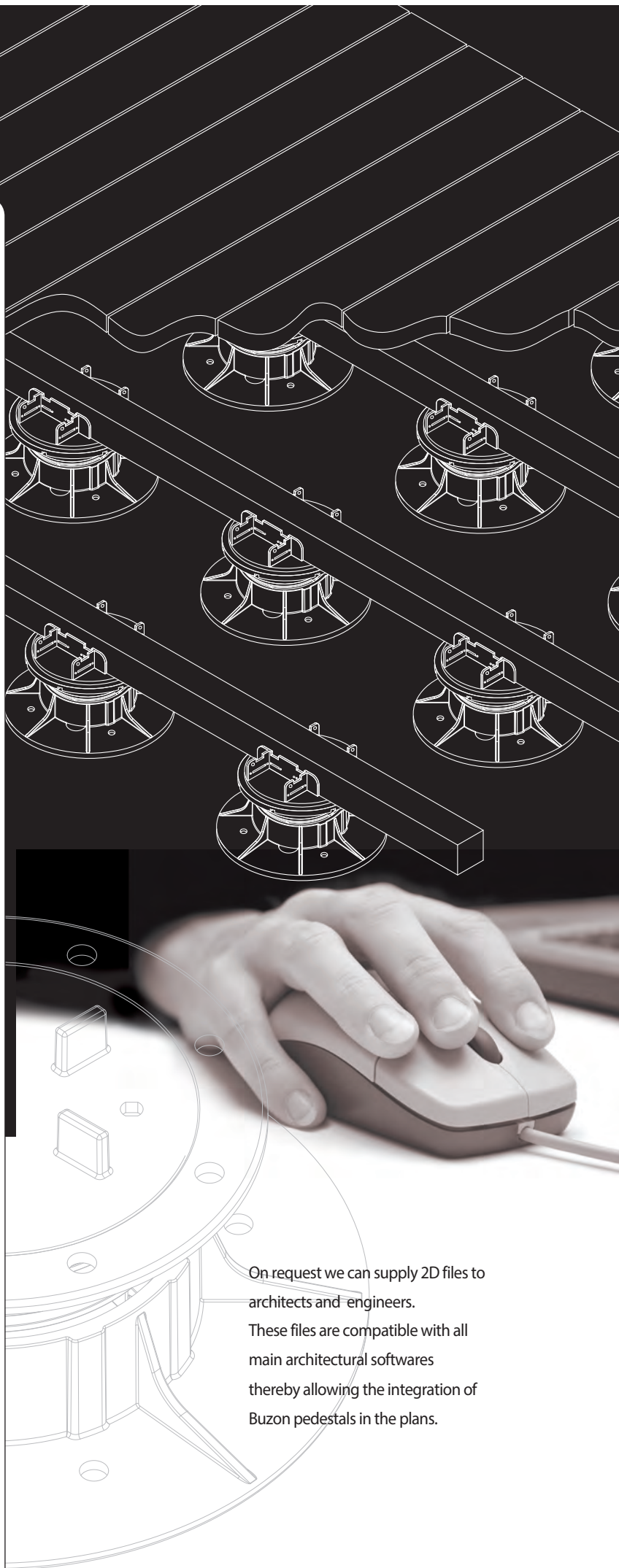
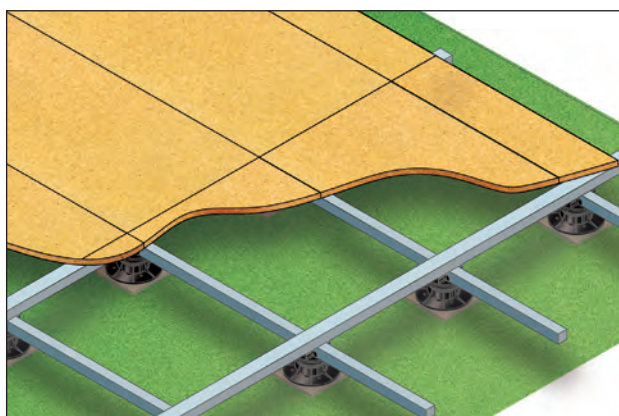
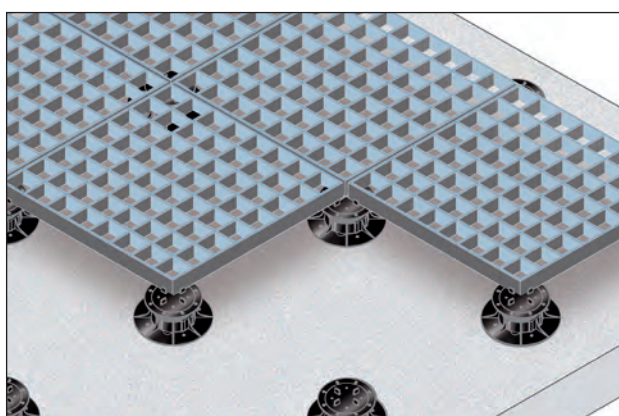
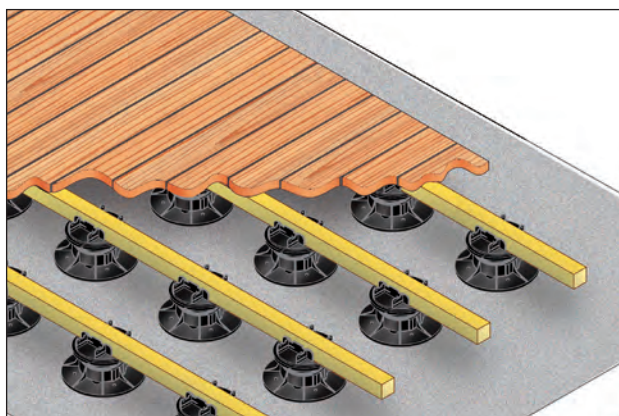
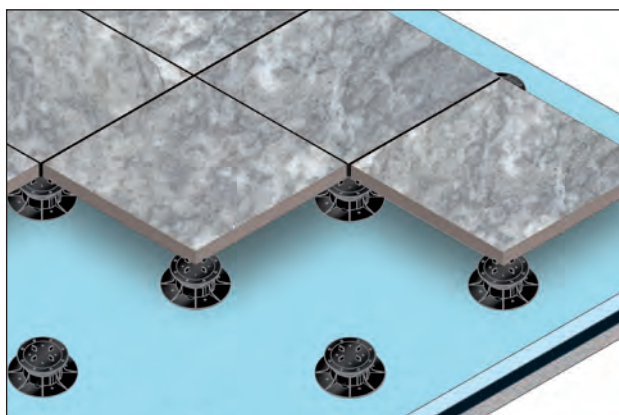

On request we can supply 2D files to architects and engineers. These files are compatible with all main architectural softwares thereby allowing the integration of Buzon pedestals in the plans.

* Specification test on request

Height of Buzon Screwjack pedestals

Adjustable pedestals from 42 to 600 mm

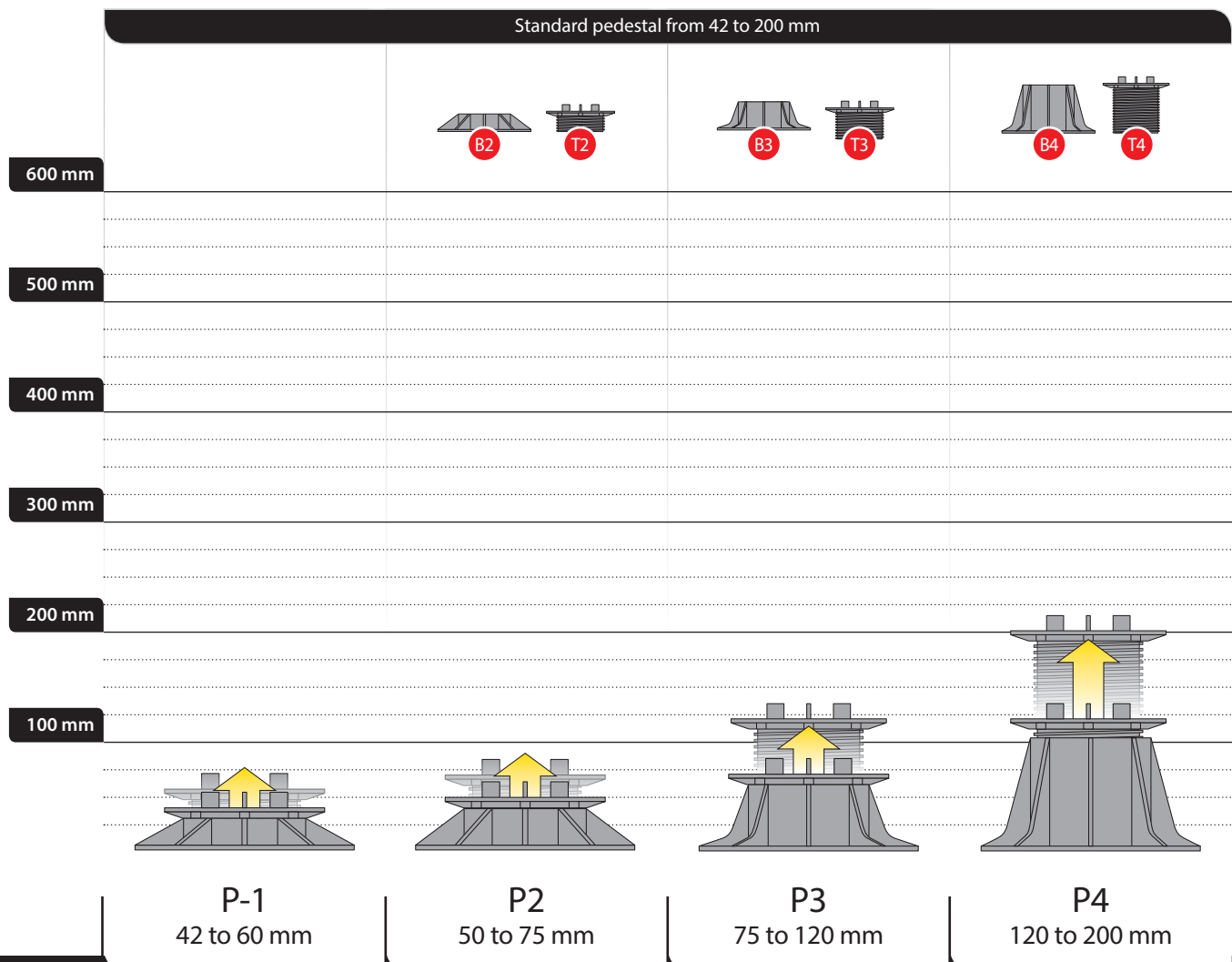

Accessories



Shim

1 or 2 mm EPDM; reinforced (Shore 50), for use with marble granite, stone tiles to act as:

- Anti Slip,
- Shock absorber

Also compensates the difference in thickness of the stone tiles, used during installation.



Head NT (Tab free)

Head of the pedestal without tabs. Plane surface allow fixation of all types of structures, like timber joists of any size for deckings.



Head with Tabs 4mm

Head of pedestal with tabs 4mm, H : 17mm. Plane surface allowing to use all types of stone, concrete and ceramic slabs.

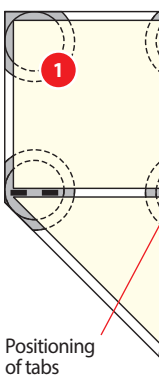



*Test available on request

Extensions from 190 to 600 mm (with the C1 coupler)

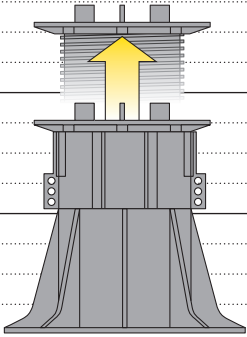
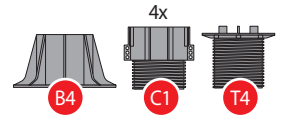
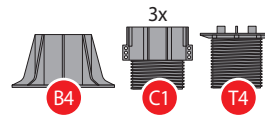
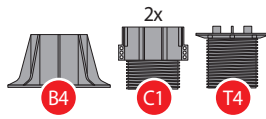
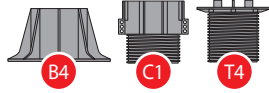
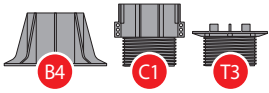

P6
190 to 270 mm

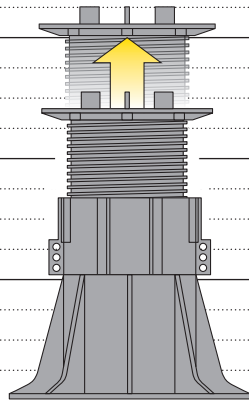

P7
240 to 310 mm

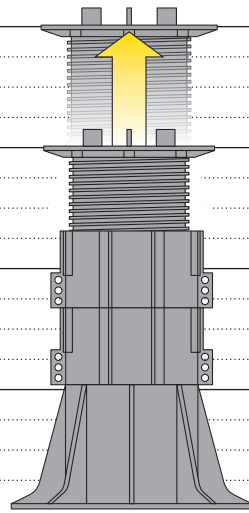

P8
300 to 400 mm

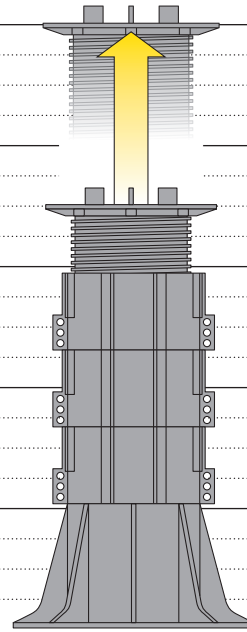

P10
350 to 500 mm

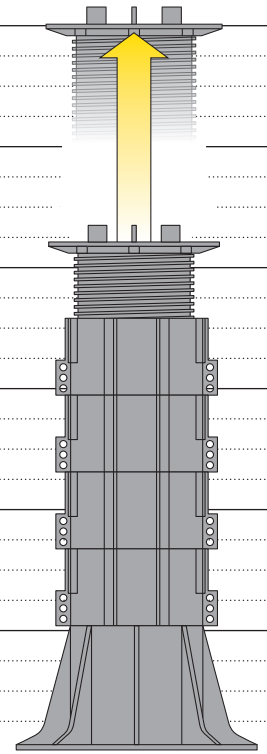

P12
420 to 600 mm

Laying out and cutting of the pedestals

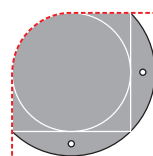
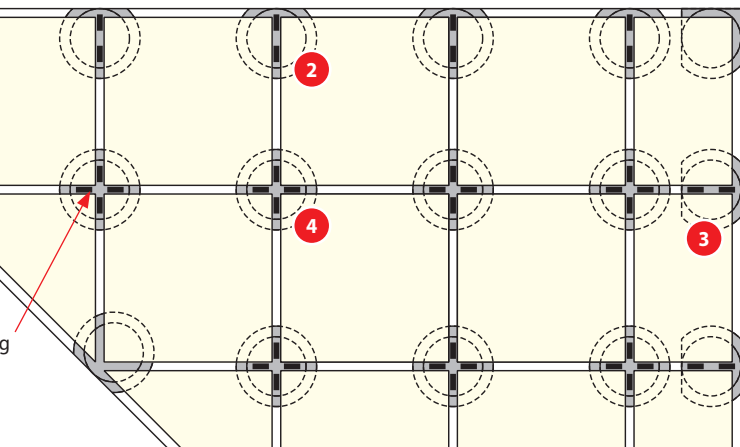

1 Pedestal with a cut base on two perpendicular sides and without tabs for use in a corner.

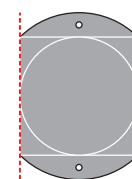

3 Pedestal with cut base on two parallel sides and two removed tabs.

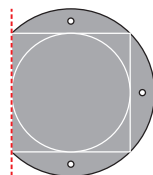

2 Pedestal with cut base on one side and two of the four tabs removed for use on the wall.

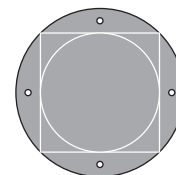

4 Pedestal with the complete base and the four tabs.

Natural stone slabs, concrete pavers



Applications



Industrial floors

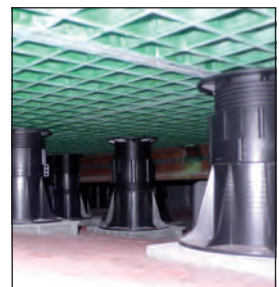

Ceramic tiles



Applications



Timber terraces and decks

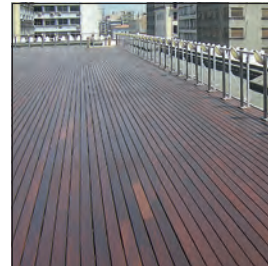

Applications

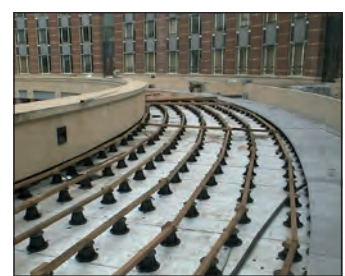



ACROPOLIS MUSEUM – GREECE



LIEGE UNIVERSITY HOSPITAL – BELGIUM



EUROPEAN CENTRAL BANK HEAD OFFICE – G-D LUXEMBOURG



CHAMBER OF COMMERCE – LUXEMBOURG



OFFICE BUILDING – GREECE



PETRONAS TOWER - KUALA LUMPUR (MALAYSIA)

References

- Marina Bay sands Hotel - Singapore
- Seat of the Parliament of the EU, Brussels - Belgium
- Military royal school, Brussels - Belgium
- National museum of Tokyo - Japan
- University hospital of Kansas City - the United States
- Building of the seat of the European Parliament, Strasbourg - France
- Site of the General society, Brussels - Belgium
- Bank Communal Crédit, Brussels - Belgium
- Disneyland, Paris - France
- Industrial laboratory of Films FUJY - France
- Metro Station - Lisbon (Portugal)
- Petronas Tower - Kuala Lumpur – Malaysia
- Diabete Treatment Center – Kuwait
- National Theater– Singapore
- City Bank – Bahrain
- Winn Hotel – Las Vegas
- Berlaimont – Bruxelles - Belgium



Marina Bay sands Hotel - Singapore



BEGIUM ROYAL SCHOOL – BELGIUM



AMUSEMENT PARK – BELGIUM



DENVER HOSPITAL – USA



EUROPEAN PARLEMENT – STRASBOURG (FRANCE)



TEMPLE – TOKYO (JAPAN) – ARCH, SHINKENCHIKU-SHA

Decorum Concept Group

Moletu str. 13, Vilnius, Lithuania, LT-14260

Raudondvario str. 242 G, Kaunas, Lithuania, LT-47159

Tel/Fax : +37052730902, Mob : +37068267670

info@dcg.lt

www.dcg.lt

BUZON Pedestal International s.a.

Z. l. des Hauts-Sarts, Zone 1

Prolongement de la rue de l'Abbaye

B-4040 Herstal (Belgique – Europe)

Tél. : +32 (0)4 248 39 83 – Fax : +32 (0)4 264 82 38



info@buzon.eu – www.buzon.eu